



# Electro-Voice®

Owner's Manual



**UCC 1**  
**USB-CAN CONVERTER**

## Contents

1.	Description.....	17
2.	Controls and Connections.....	18
3.	Installation .....	19
3.1	Unpacking.....	19
3.2	Rack-Mounting.....	19
4.	Initial Operation.....	20
4.1	PC Connection and CAN Driver Installation .....	20
4.2	Installing IRIS.....	20
4.3	CAN-Bus Connection.....	20
4.4	ISOLATED / GROUNDED Switch .....	22
5.	Monitor Bus.....	23
6.	Technical Information .....	23
6.1	The UCC1 USB-CAN Converter .....	23
6.2	The CAN-Bus Standard.....	24
6.3	Maximum Cable Length on the CAN-Bus .....	25
7.	Specifications.....	27

## 1. Description

The UCC1 USB-CAN CONVERTER is a bi-directional USB-to-CAN interface converter and is therefore the perfect solution for interconnecting Electro-Voice appliances with serial CAN-busses and PC or Notebook computers.

The UCC1 is a standalone unit with interface drivers for CAN and USB, audio monitoring output, USB and CAN controllers as well as microphone controllers for converting commands and data between PC and CAN-bus-units. The isolated CAN-bus interface reduces ground-loop interference noise to an absolute minimum. The UCC1 receives its operational power via USB from the connected PC, so that no external power supply unit is needed.

This owner's manual illustrates installation and initial operation of the UCC1 when used together with Electro-Voice P-Series Remote Amplifiers. Please, carefully read and mind all instructions and precautions. Keep this owner's manual at a save place for further reference.

### Characteristics

- Data rate up to 500 kbit/s
- Galvanic separation of the CAN-bus, switchable
- 100 network devices possible
- Monitor-bus in network cabling; output signal via XLR-type connector
- Power supply via USB from the connected PC; separate power supply unit is not needed

## 2. Controls and Connections

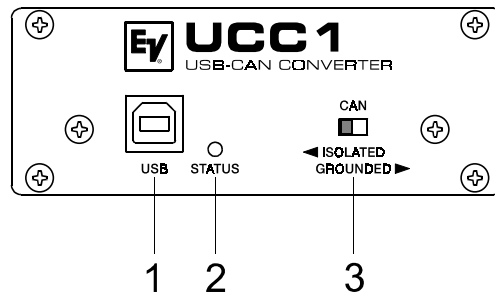

Fig. 1: UCC1 front panel

### 1. USB connector

This connector is for the connection to the USB-port on your PC. The interface complies with the USB 1.1 specifications and offers data transfer as well as operation voltage supply for the UCC1.

### 2. STATUS indicator

The STATUS LED indicates the actual operational state of the UCC1. The indicator lights when the UCC1 has been connected to the PC, the dedicated driver software has been installed, and the PC has recognized the unit. The LED blinks during data accesses.

### 3. CAN ISOLATED / GROUNDED switch

Setting this switch to ISOLATED galvanically isolates the CAN-port of the UCC1 from the rest of the circuitry, effectively eliminating ground-loop interference noise. Setting the switch to GROUNDED galvanically connects the CAN-bus to the USB-port ground and thus to the PC.

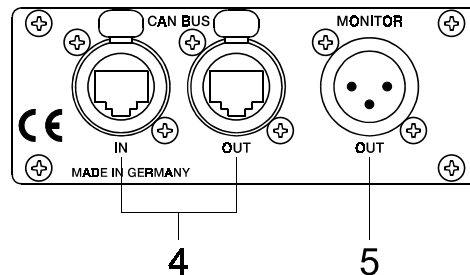

Fig 2: UCC1 rear view

### 4. CAN BUS IN / OUT connectors

These two sockets are for connecting EV-appliances that are furnished with serial CAN-bus. Both connectors are connected in parallel for convenient carrying through CAN-bus data.

### 5. MONITOR connector

The MONITOR connector provides audio signal output for the monitor bus of EV P-Series Remote Amps. The monitor bus allows listening to the audio signal of any amplifier within the system, without the need for additional wiring.

### 3. Installation

#### 3.1 Unpacking

The UCC1 package includes the following parts:

- 1 UCC1 USB-CAN CONVERTER
- 1 Front panel 19", 1HU
- 2 CAN-TERM 120  $\Omega$  CAN-bus terminator-plug
- 4 Rubber feet
- 1 USB cable
- 1 Owner's manual

Upon receiving your UCC1, please inspect the contents of the package for loss or damage. If any of the here listed parts are missing or damaged, please immediately contact your distributor or a TELEX / EVI Audio service center.

#### 3.2 Rack-Mounting

The compact UCC1 adapter is mainly aimed for connection to a laptop or notebook computer. However, the supplied 19" front panel allows trouble-free integration in a rack shelf system. For mounting the 19" front panel, please proceed as follows:

1. Loosen the two center screws on the UCC1's panel (1).
2. Loosen the four corner screws on the UCC1's panel (2).
3. Remove the original UCC1 panel (3).

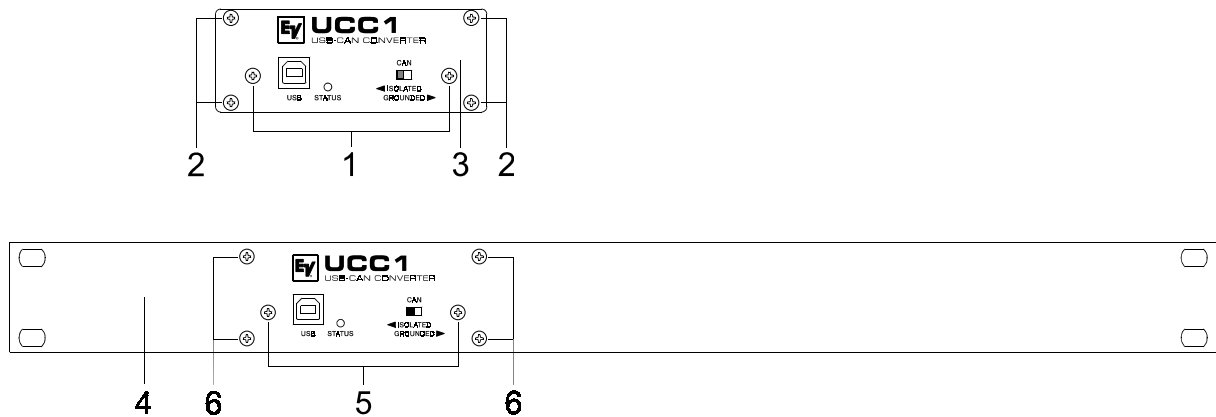

Fig. 3: Exchanging UCC1 front panels

4. Fix the 19" front panel on the UCC1. In doing so, make sure not to damage, bend or stress the STATUS indicator and the ISOLATED / GROUNDED switch. (4).
5. Reinsert and tighten the two center screws of the UCC1 19" panel (5).
6. Reinsert and tighten the four corner screws of the UCC1 enclosure (6).

Now you are able to install the UCC1 in a rack shelf system securing it with the four rack-screws on the sides.

## 4. Initial Operation

Follow these four steps when operating the UCC1 for the first time: Connect the UCC1 to the PC and install the CAN drivers, install the IRIS-software, connect the desired appliances to the CAN-bus, and set the ISOLATED / GROUNDED switch accordingly.

### 4.1 PC Connection and CAN Driver Installation

Use the supplied USB cable for connecting the UCC1 to your PC's or Notebook's USB-socket. The computer system normally recognizes the UCC1 at once and the operating system asks for the corresponding driver software. This files are stored in the root directory of the IRIS CD.

Insert the IRIS CD in your CD-drive and select the corresponding drive in the installation dialog. The operating system will find all necessary driver files there. For correct installation follow the instructions on your computer screen. For further information please check the IRIS Readme-File, also.

The UCC1 is ready for operation as soon as the STATUS LED lights.

### 4.2 Installing IRIS

Next, you have to install the IRIS – Intelligent Remote & Integrated Supervision – software package on your PC or Notebook computer. Detailed explanation is provided in the accompanying IRIS Readme-File. Just follow the instructions in the installation dialog.

The STATUS LED blinks whenever the IRIS program is started and accesses the UCC1, indicating that USB-port data communication has been activated.

### 4.3 CAN-Bus Connection

The CAN-bus is a serial interface for transferring commands and data. Since the CAN-bus is based on serial bus architecture, all participating appliances have to be connected in series, i.e. cables have to run from each participant on the bus system to the next. Whether a connected appliance is an amplifier or the UCC1 USB-CAN Converter is generally of no further importance, which allows the integration of the UCC1 – and therefore the PC – at any point on the CAN-bus. Including several UCC1s and PCs on a single CAN-bus is possible as well.

Each participant on the bus system has two RJ-45 connectors for the Remote CAN-bus. These sockets are connected in parallel to serve as input and output for carrying through the data information of the remote-network. The CAN-port follows balanced design, which makes the use of Twisted-Pair cables absolutely mandatory.

Both ends of the CAN-bus have to be terminated with 120  $\Omega$ . Two CAN-TERM 120  $\Omega$  termination plugs are supplied with the UCC1. Connect one of these each to the RJ-45 connector that is not in use of the first and the last appliance on CAN-bus.

The following diagrams are examples of the system cabling for different order of size configurations:

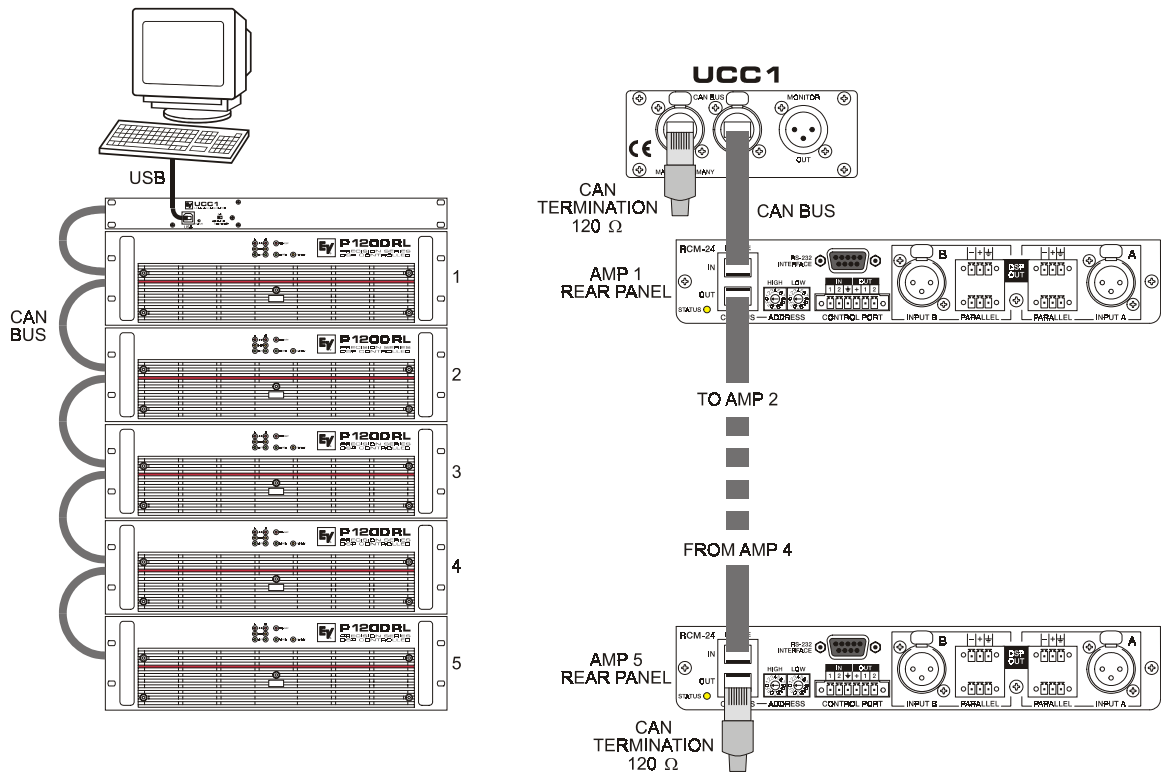

Fig 4: System set-up with 5 amps and a single UCC1 / PC being the first unit on the bus Terminators at the UCC1 (first unit) and at the amp No.5 (last unit on the bus)

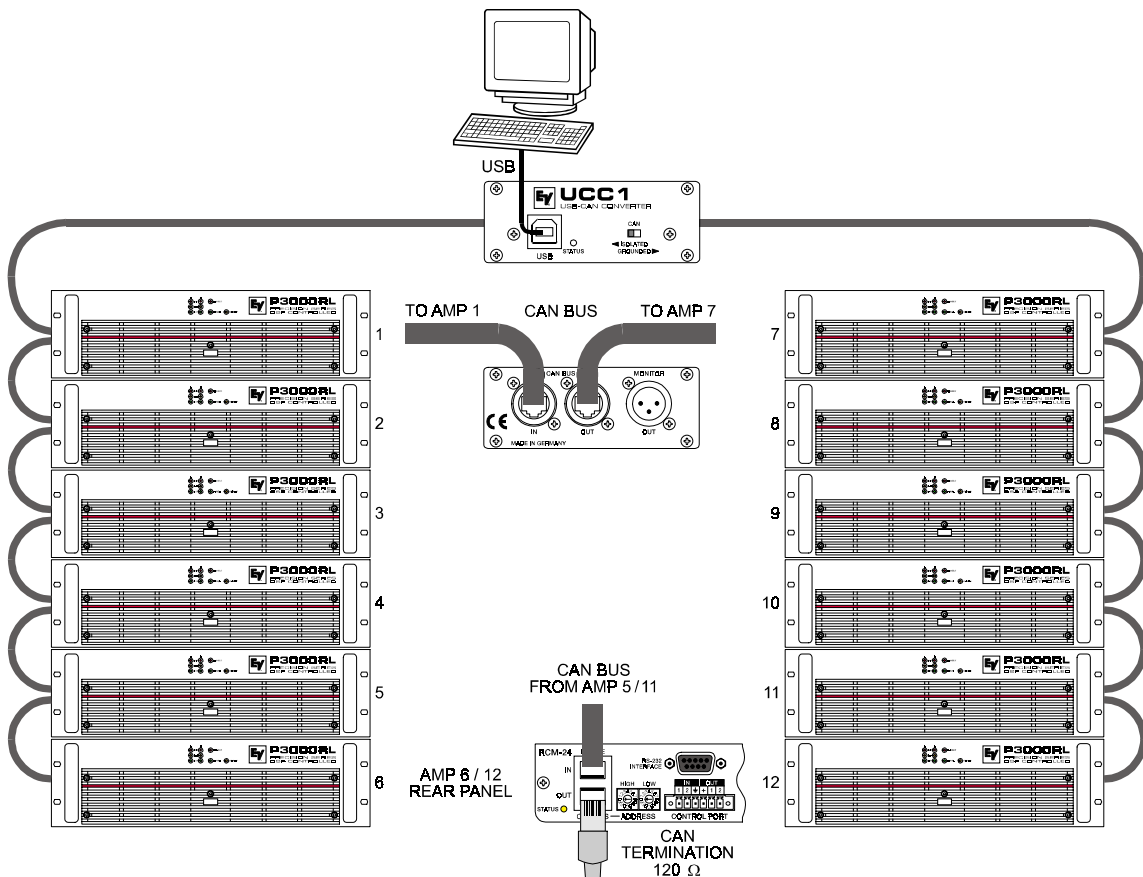

Fig 5: System set-up with 2 racks and a single UCC1 / PC in the middle Terminators at amp No. 6 (first unit) and amp No. 12 (last unit on the bus)

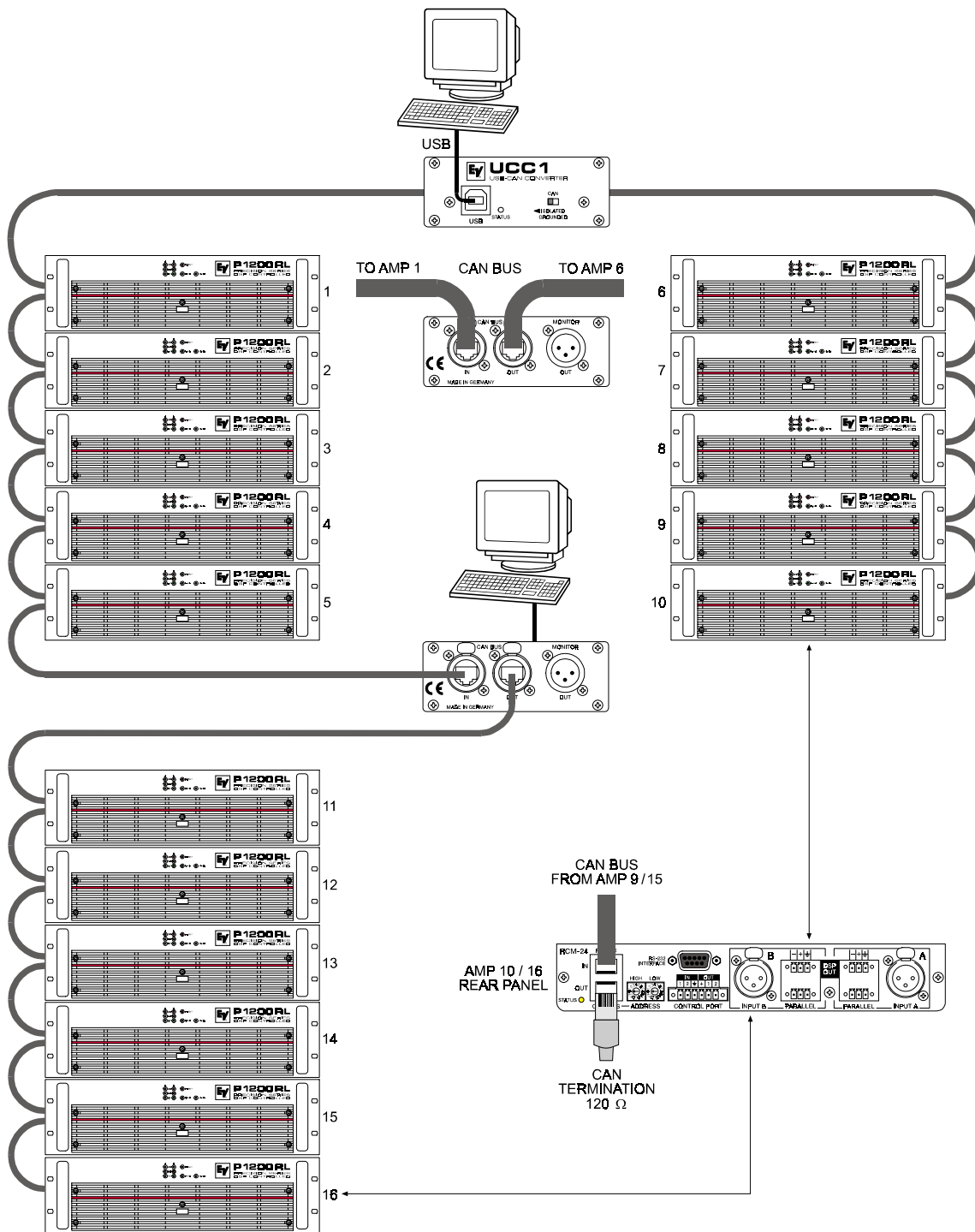

Fig 6: System with several racks and several UCC1 / PCs  
 UCC1 anywhere on the CAN-bus  
 Terminators at amp No. 10 (first unit) and amp No. 16 (last unit on the bus)

#### 4.4 ISOLATED / GROUNDED Switch

Principally, the CAN-bus is galvanically isolated from any other participant on the bus, i.e. from all P-Series Remote amps and from the UCC1 USB-CAN Converter as well, a circumstance which as a matter of fact results in effective elimination of ground-loop interference noise.

The ISOLATED / GROUNDED switch located on the UCC1's front panel allows bridging this galvanic isolation putting the CAN-bus of the UCC1 on circuitry ground potential.

The CAN-bus should normally be referenced to the ground potential at one single point in the network. Set the switch to its GROUNDED-position when only one UCC1 is used in a single CAN-bus network. When employing several UCC1s in a CAN-bus network, setting the ISOLATED / GROUNDED switch of one UCC1 to GROUNDED while leaving the switches of all other UCC1s in the ISOLATED-position is recommended.

## 5. Monitor Bus

Next to the CAN-bus signal, network cabling also holds the balanced audio-monitor signal for monitoring the power amp inputs and outputs. This monitor-bus allows software-controlled monitoring of the input and output signals of all power amps that are included in the remote network, without the need for additional wiring. The monitor signal is present at the UCC1's XLR-type MONITOR Output connector for further distribution to (e.g.) a mixing console to be monitored via headphones or an active monitor speaker connected.

## 6. Technical Information

### 6.1 The UCC1 USB-CAN Converter

The UCC1 is an USB-to-CAN adapter, which offers the possibility to easily include any PC or Notebook computer that is equipped with an USB-port in an existing CAN-network. The USB driver, which is part of the IRIS-software is the only thing needed for triggering. The UCC1 gets its power supply from the PC's USB-port, so that no external power supply unit is necessary.

The following block diagram shows the UCC1's internal structure with USB-port and controller on the one side and the CAN-bus interface with CAN-transceiver component and galvanic separation on the other side. The controller is responsible for the data format conversion between USB-port and CAN-bus, allowing data rates of up to 500 kbit/s.

Next to the CAN-bus, the network cabling also holds the monitor bus, which serves for monitoring the input or output audio signals of all amplifiers that are included in the network. This audio signal is present at the UCC1's XLR-type MONITOR Output connector to provide trouble-free connection to a mixer input or an additional amplifier.

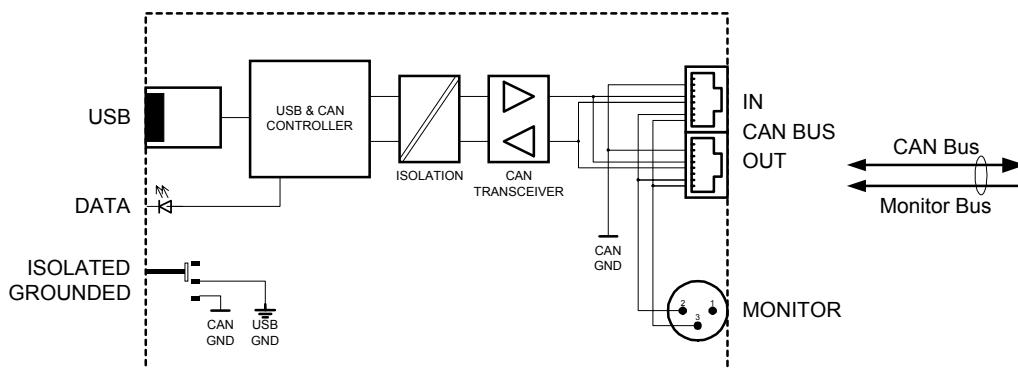

Fig. 7: UCC1 Block Diagram

The CAN-bus port of the UCC1 (CAN BUS IN / OUT) is carried out via two Neutrik EtherCon connectors to ensure most secure and reliably safe RJ-45 connections even under most wearing conditions. The EtherCon connector series has been specially designed for use in ProAudio and On-Stage applications. Matching Neutrik plug-type – NE8MC – connectors are also available.

The pin-assignment of CAN-bus connectors is shown in figure 8.

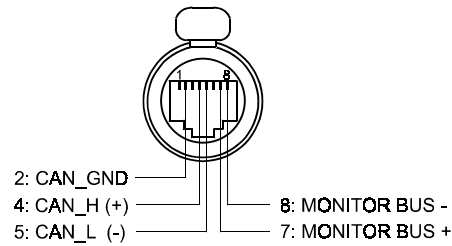

Fig. 8: CAN BUS IN / OUT connector pin-assignment

## 6.2 The CAN-Bus Standard

Developed in the 1980's, the CAN-bus norm had been established in the 1990's by the International Standardization Organization (ISO) as a worldwide standard. Since then, CAN has become very popular especially in automotive and industrial applications. CAN is cared for and further developed by the CiA (CAN in Automation User Organization), an association of 300 well-known companies engaged in different areas.

The CAN-Bus employs the so-called „Bus-Topology“ as network topology; i.e. all participants on the bus are connected via one single two-wire line (Twisted-Pair-cable, with or without shielding), which, at its ends has to be terminated using 120  $\Omega$  bus termination plugs. Each appliance on the bus can communicate with any other unit without restriction. Up to 100 network devices can be connected on a single CAN-Bus.

Because the CAN-interfaces of all EVI Audio appliances is galvanically isolated from the rest of the circuitry, network cabling also carries a common ground (CAN\_GND), which guarantees that all CAN-interfaces in the network are connected to the same ground potential. The ISOLATED / GROUNDED switch in the UCC1 offers the possibility for switching the CAN-Ground (CAN\_GND) to circuitry ground potential. Normally, one UCC1's switch should be set to its GROUNDED-position while all other UCC1s in the network should be set to ISOLATED.

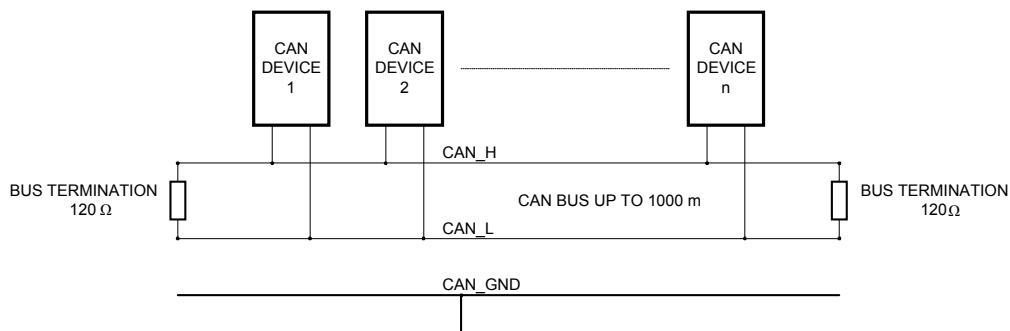

Fig. 9: Bus-topology of the CAN-bus

The CAN-bus allows using different data rates. The actual data rate is indirect proportional to the bus length. „Smaller“ networks with short bus lengths permit higher baud rates of up to 500 kbaud. The baud rate needs to be reduced (minimum 10 kbaud) in networks with extensive bus length. The following table shows the relation between baud rate and bus length:

Baud Rate	Bus Length
500 kbit/s	100 m
250 kbit/s	250 m
125 kbit/s	500 m
62,5 kbit/s	1000 m
20 kbit/s	2500 m
10 kbit/s	5000 m

The use of repeaters is generally recommended when a network's bus length exceeds 1000 m.

### 6.3 Maximum Cable Length on the CAN-Bus

According to the ISO 11898-2 standard, CAN-bus data transfer cabling has to be carried out using Twisted-Pair cables with or without shielding providing a characteristic impedance of 120 Ω. Both ends of a CAN-network have to be terminated with 120 Ω termination plugs.

The maximum bus length depends on the actual data transfer rate, which kind of data transfer cable is used and the total number of participants on the bus. The following table shows the most essential coherencies for CAN-networks consisting of up to 64 participants:

Bus Length	Data Transfer Cable		Termination	Max. Data Transfer Rate
	Length-Related Resistance	Cable Diameter		
0 ... 40 m	< 70 mΩ/m	0,25 ... 0,34 mm <sup>2</sup> AWG23, AWG22	124 Ω	1000 kbit/s for 40 m
40 ... 300 m	< 60 mΩ/m	0,34 ... 0,6 mm <sup>2</sup> AWG22, AWG20	127 Ω	500 kbit/s for 100 m
300 ... 600 m	< 40 mΩ/m	0,5 ... 0,6 mm <sup>2</sup> AWG20	150 ... 300 Ω *	100 kbit/s for 500 m
600 ... 1000 m	< 26 mΩ/m	0,75 ... 0,8 mm <sup>2</sup> AWG18	150 ... 300 Ω *	62,5 kbit/s for 1000 m

\* To reduce the load for the interface driver and therefore also reducing the voltage drop between the two cable ends, using higher impedance termination than the specified 120 Ω is recommended for networks with increased cable length and many nodes on the CAN-bus.

The following table is for estimating the necessary cable diameter in relation to the length and the amount of participants on the bus:

Bus Length	Number of Units on the CAN-bus		
	32	64	100
100 m	0,25 mm <sup>2</sup> respectively AWG24	0,34 mm <sup>2</sup> respectively AWG22	0,34 mm <sup>2</sup> respectively AWG22
250 m	0,34 mm <sup>2</sup> respectively AWG22	0,5 mm <sup>2</sup> respectively AWG20	0,5 mm <sup>2</sup> respectively AWG20
500 m	0,75 mm <sup>2</sup> respectively AWG18	0,75 mm <sup>2</sup> respectively AWG18	1,0 mm <sup>2</sup> respectively AWG17

Additionally, the length of any stub lines for participants that are not directly connected to the CAN-bus needs to be kept in mind. For data transfer rates of up to 125 kbit/s the length of a single stub cable should not exceed 2 m. For higher bit rates a length of max. 0.3 m has not to be exceeded. The entire length of all stub lines should not exceed 30 m.

**General note:**

**Using commercial quality RJ-45 patch cables with a characteristic impedance of 100  $\Omega$  (AWG 24 / AWG 26) for rack cabling is generally possible for short distances of up to 10 m.**

**For the interconnection of rack shelf systems as well as in fixed installations obeying the guidelines for network cabling, as mentioned above, is mandatory.**

## 7. Specifications

### CAN BUS:

Sockets	2 x RJ-45 parallel (NEUTRIK EtherCon compatible)
Baud Rate	500 / 250 / 125 / 62,5 / 20 / 10 kbit/s
Number of Nodes	100 max.
Data Format	CAN specification 2.0B (29 bit ID)
Cable Length	1000 m at 62,5 kbit/s

### USB:

Socket	USB socket, Type B
Standard	USB 1.1
Cable Length	3m max.

### MONITOR:

Socket	XLR male, electronically balanced (Pin 2 = +, Pin 3 = -)
Output Voltage (nominal)	1.55 V / +6 dBu
Max. Output Voltage	8.7 V / +21 dBu
Output Impedance	< 100 $\Omega$
Min. Load Impedance	600 $\Omega$

Power Supply	+ 5 V DC (from USB interface)
Power Consumption	200 mA max.
Operation Temperature Range	0 °C ... 50 °C
Certified	CE

Dimensions	105 x 39.5 x 130.4 mm (W x H x D)
with 19" panel	483 x 43.6 x 130.4 mm (W x H x D), 19" / 1 HU
Weight	0.8 kg (with 19" panel)

Accessories	19" panel for rack installation CAN-TERM 120 $\Omega$ termination plug (2x)
-------------	--

- subject to changes without further notice -